

aspex

---

RESIDENTIAL DOORSETS  
Ultimate interior fitout solutions

DOORSETS | IRONMONGERY | ACCESS CONTROL

---

[www.aspex.co.uk](http://www.aspex.co.uk) | [info@aspex.co.uk](mailto:info@aspex.co.uk)



# RESIDENTIAL DOORSETS

CONTEMPORARY, SECURE, SAFE

## Designs

**Panelled**



**Grooved**



**Flush**



## Finishes

**Painted**



**Veneer**



**Laminated**

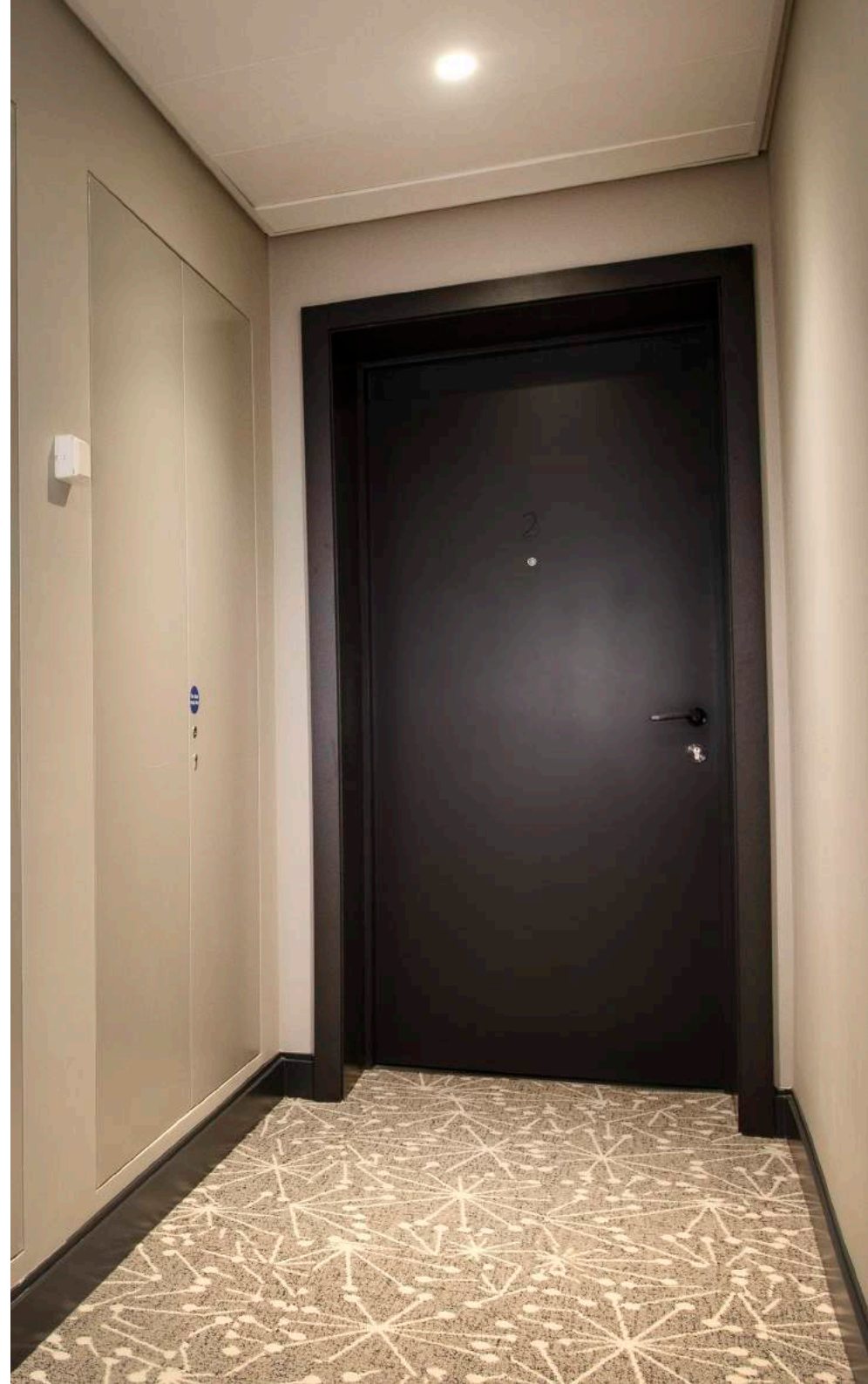

## PAS24 ENTRANCE DOORSETS

A range of Residential Apartment Entrance doorsets available in industry-standard and bespoke sizes and a variety of different designs and finishes.

The doorsets are supplied fully assembled with the mortice ironmongery installed with frames, extension linings and architraves either primed or finished to match the door leaf.



# PAS24 ENTRANCE DOORSETS

## DESIGN

- Flush, Paneled or grooved door leaf
- Hardwood rebated frames either primed or finished to match the door leaf
- Adjustable Extension linings
- Architrave in a variety of designs and sizes
- Plinth Blocks
- Wall panels Class 0 rated
- Hardwood thresholds
- Door leaf size of up to 2400mm high and 1200mm wide

## FINISH

- Primed - Smooth finish for onsite painting
- Factory Painted - Any RAL colour with the option for different colours on each side
- Laminated - Extensive range available
- Veneered - Natural wood or dyed options to choose from
- Stained - Select from a standard range or bespoke to match other elements in the apartment

## SPECIFICATION

- FD30S (44mm) and FD60S (54mm)  
Fire rated
- All fire rated doorsets are manufactured under the stringent IFC certification scheme
- 29db, 32db or 35db Acoustic rated
- PAS24: 2016 Security rated
- Smoke / Air tested - Compression smoke seals tested in accordance with BS 9999:2017
- FSC Certified
- Key or Electronic locking with either NSP or Salto handle sets
- Concealed or surface mounted door closer





## INTERNAL APARTMENT DOORSETS

A range of Residential Apartment doorsets available in industry-standard and bespoke sizes and a range of different designs and finishes.

The doorsets are supplied fully assembled with the mortice ironmongery installed with frames and architraves either primed or finished to match the door leaf.

Stained Veneered



Matte Fog Laminate



Painted Rec Groove



# INTERNAL APARTMENT DOORSETS

## DESIGN

- Flush, Paneled or grooved door leaf
- Lining and stop or rebated frames either primed or finished to match the door leaf
- Architrave in a variety of designs and sizes
- Plinth Blocks
- Door leaf size of up to 2400mm high and 1200mm wide

## FINISH

- Primed – Smooth finish for onsite painting
- Factory Painted – Any RAL colour with the option for different colours on each side
- Laminated – Extensive range available
- Veneered – Natural wood or dyed options to choose from
- Stained – Select from a standard range or bespoke to match other elements in the apartment

## SPECIFICATION

- NFR (44mm), FD30S (44mm) and FD60S (54mm) Fire rated
- All fire rated doorsets are manufactured under the stringent IFC certification scheme
- 29db, 32db or 35db Acoustic rated
- FSC Certified



# NOVISTA POCKET SLIDING DOORS

Novista sliding door systems are an ideal space saver as the door leaf opens into the wall cavity, leaving the wall and the area around the door clear.

## POCKET SLIDING DOORS

- Architrave free
- Sleek and elegant design
- Door completely disappears into wall cavity
- Full height or “infinite” installation possible
- Silent and smooth operation with nylon rollers and aluminum track
- Timber and glass doors
- Single, double or telescopic options

## GLASS SLIDING DOORS

- Glass option available on both inwall and full height options
- Glass thickness of 8mm, 10mm or 12mm thick



## COMMUNAL DOORSETS

A range of doorsets for the communal spaces available in industry-standard and bespoke sizes, and a choice of different designs and finishes.

The doorsets are supplied fully assembled with the mortice ironmongery installed with frames, extension linings and architraves either primed or finished to match the door leaf.

Matte Kashmir Laminate

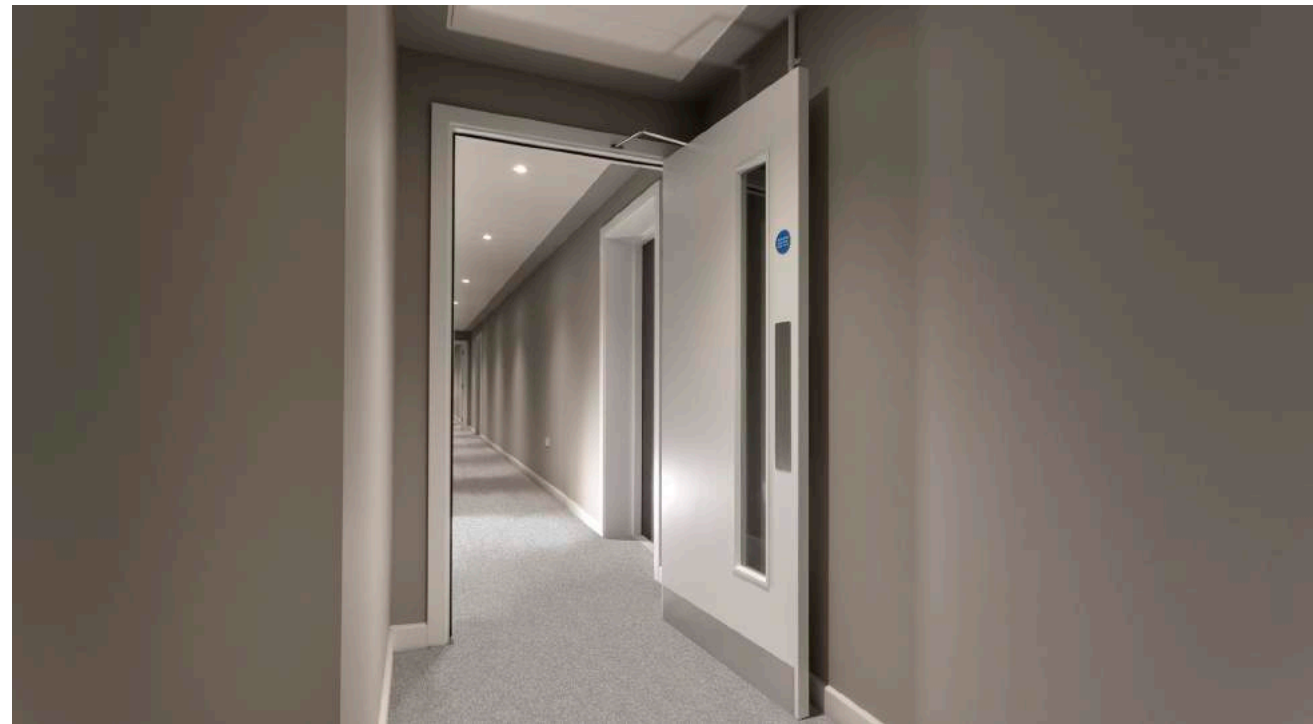
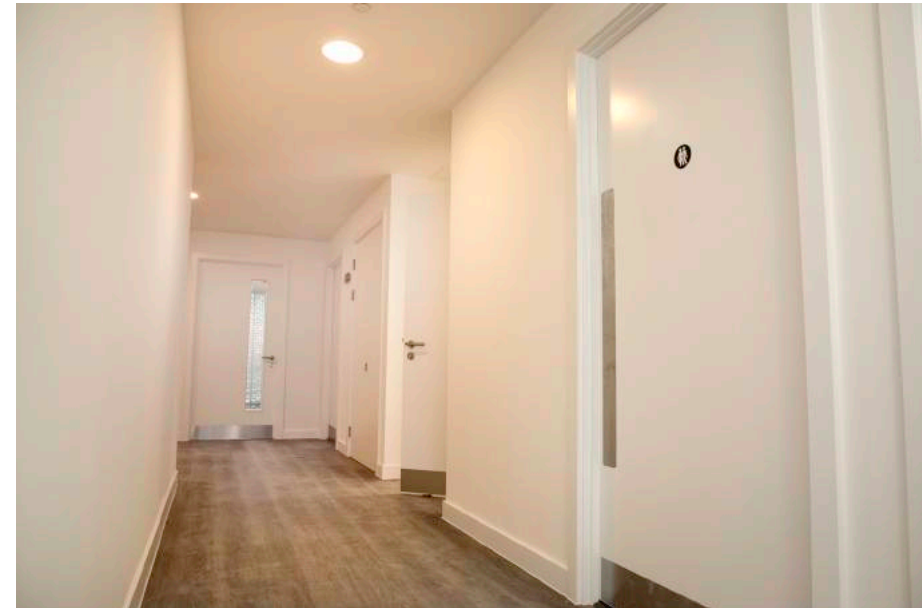



# COMMUNAL DOORSETS

## DESIGN

- Flush, Paneled or grooved door leaf
- Lining and stop or rebated frames either primed or finished to match the door leaf
- Adjustable Extension linings
- Architrave in a variety of designs and sizes
- Plinth Blocks
- Wall panels Class 0 rated
- Hardwood thresholds
- Door leaf size of up to 2400mm high and 1200mm wide
- Choice of vision panel designs and sizes available

## FINISH

- Primed - Smooth finish for onsite painting
- Factory Painted - Any RAL colour with the option for different colours on each side
- Laminated - Extensive range available
- Veneered - Natural wood or dyed options to choose from
- Stained - Select from a standard range or bespoke to match other elements in the apartment

## SPECIFICATION

- NFR (44mm), FD30S (44mm), FD60S (54mm), FD90S (64mm) and FD120 (59mm)  
Fire rated
- All fire rated doorsets are manufactured under the stringent IFC certification scheme
- 29db, 32db, 35db or 40db Acoustic rated
- PAS24: 2016 Security rated
- Smoke / Air tested - Compression smoke seals tested in accordance with BS 9999:2017
- FSC Certified



## PAS24 ACCESS CONTROLLED COMMUNAL DOORSETS

A range of PAS24 security rated doorsets which can be connected to any access control system

The doorsets are secured using an electric strike and heavy-duty latch and have been PAS24 tested from both sides and these will open automatically in the event of a fire

Available in industry-standard and bespoke sizes and a variety of different designs and finishes.

The doorsets are supplied fully assembled with the electric strike and latch installed with frames, extension linings and architraves either primed or finished to match the door leaf.

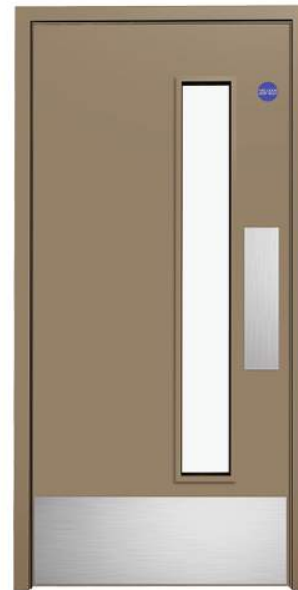

PUSH SIDE



PULL SIDE

Matte Kashmir Laminate

Mocca Firwood Laminate

Classic Wenge Laminate

# PAS24 ACCESS CONTROLLED COMMUNAL DOORSETS

## DESIGN

- Flush, Paneled or grooved door leaf
- Rebated frames either primed or finished to match the door leaf
- Adjustable Extension linings
- Architrave in a variety of designs and sizes
- Plinth Blocks
- Wall panels Class 0 rated
- Hardwood thresholds
- Door leaf size of up to 2040mm high and 926mm wide
- Vision panel up to 1450 x 200mm

## FINISH

- Primed – Smooth finish for onsite painting
- Factory Painted – Any RAL colour with the option for different colours on each side
- Laminated – Extensive range available
- Veneered – Natural wood or dyed options to choose from
- Stained – Select from a standard range or bespoke to match other elements in the apartment

## SPECIFICATION

- FD60S (54mm) Fire rated
- All fire rated doorsets are manufactured under the stringent IFC certification scheme
- 29db, 32db or 35db Acoustic rated
- PAS24: 2016 Security rated
- Smoke / Air tested – Compression smoke seals tested in accordance with BS 9999:2017
- FSC Certified
- 12 / 24V Electric strike compatible with any access control system
- Interchangeable between Fail Safe and Fail Locked
- Key Override



# PANEL DOORS

## DESIGN CHOICE

Luxurious panelled design, great look & feel features enhancing your interiors.

- ✓ 2 Panels
- ✓ 3 Panels
- ✓ 4 Panels

**FRAME OPTIONS:** Primed frame or matching veneered frame. Extension linings & architraves.

### FINISHES

- **Primed** - Smooth finish for onsite painting
- **Factory-painted**- Any RAL colour with the option for different colours on each side
- **Veneered** - Natural wood or dyed options to choose from
- **Stained** - Select from a standard range or bespoke to match other elements in the apartment

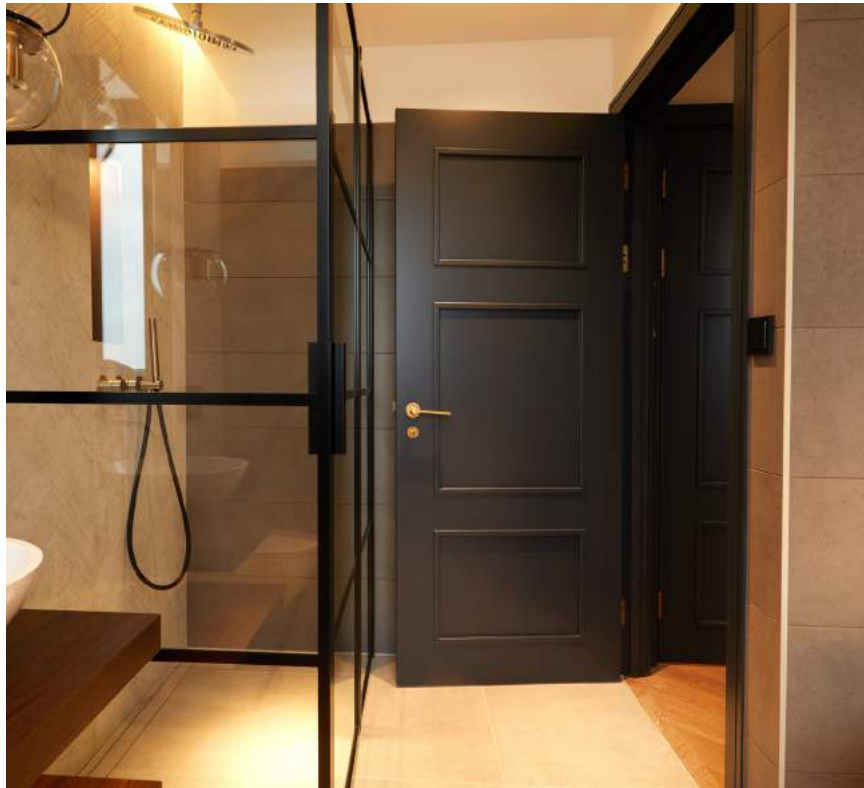



# GROOVED DOORS

## DESIGN CHOICE

Simply stunning grooved design, attention to detail features enhancing your interiors.

- ✓ Ladder
- ✓ Rectangular
- ✓ Bespoke

Groove options:

- ✓ V shape
- ✓ U shape
- ✓ L shape

Inlay options:

- ✓ Contrasting Veneer
- ✓ Aluminium

### FINISHES

- **Primed** - Smooth finish for onsite painting
- **Factory-painted**- Any RAL colour with the option for different colours on each side
- **Veneered** - Natural wood or dyed options to choose from
- **Stained** - Select from a standard range or bespoke to match other elements in the apartment

Ladder design



Rectangular design



Veneered + Grooved

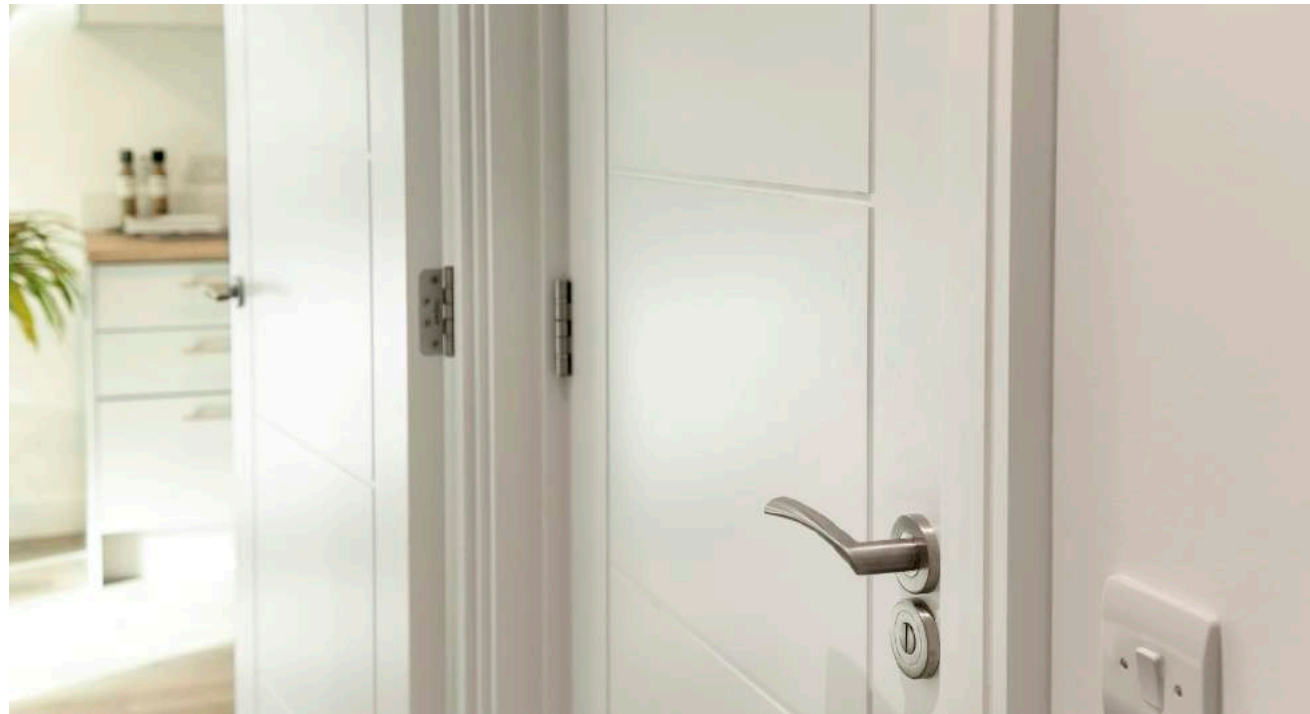

# FLUSH DOORS

## DESIGN CHOICE

Contemporary and elegant

### FINISHES

- **Primed** - Smooth finish for onsite painting
- **Factory Painted** - Any RAL colour with the option for different colours on each side
- **Veneered** - Natural wood or dyed options to choose from
- **Stained** - Select from a standard range or bespoke to match other elements in the apartment



# VENEER DOORS

## FINISH CHOICE

Real wood veneers allow the beauty of the natural wood grain and tone to be brought to life, creating a finish that preserves its true presence.

- ✓ Matt Lacquer
- ✓ Super-matt Lacquer
- ✓ Natural Veneer Crown or Quarter Cut
- ✓ Engineered Veneers
- ✓ Dyed Veneers
- ✓ Stained Veneers

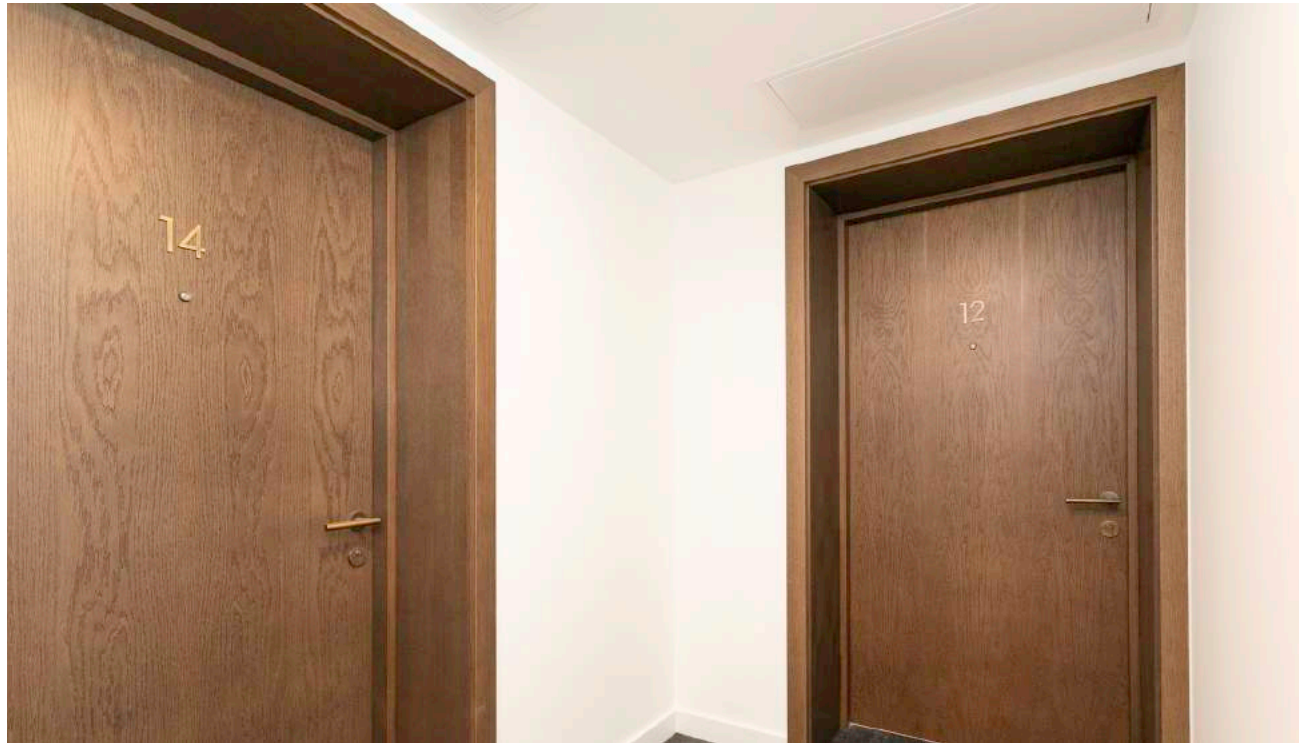
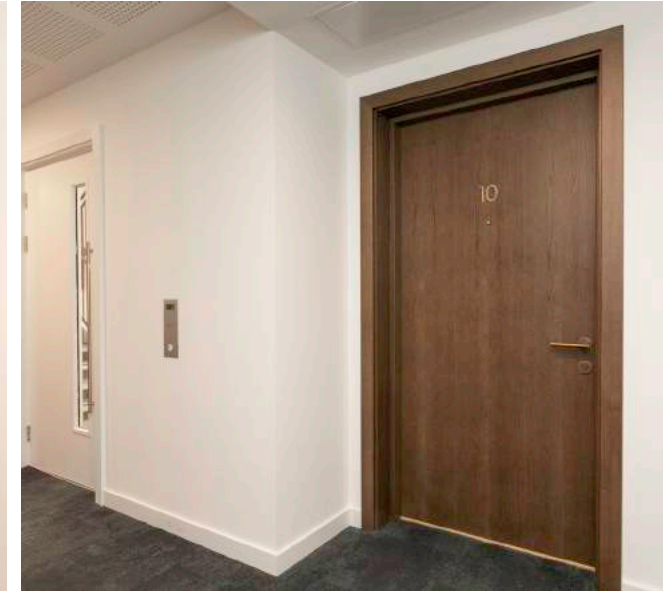

# LAMINATED DOORS

## FINISH CHOICE

Hard-wearing laminates are ideal for both aesthetic and durability requirements.

- ✓ Laminates are durable and hygienic
- ✓ Ideal choice for high-traffic door applications
- ✓ High-performance surfacing solution

Available in a range of colour and wood texture choices





## PAINTED DOORS

FINISH CHOICE

Popular factory-painted doors allow you to touch-up as needed, enhancing the look & feel easily.

Choose any RAL colour to closely match your interior look. Excellent range of standard and bespoke RAL colours

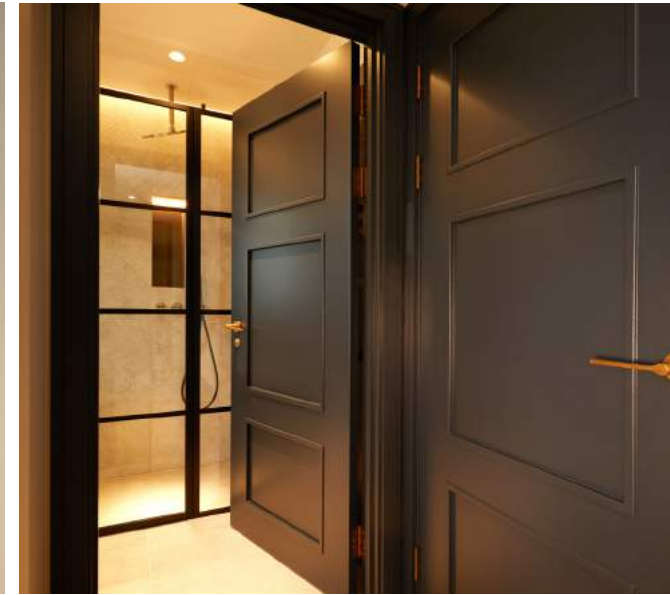

# VENEER CHOICES

Choose luxurious veneers finishes - from natural, dyed, smoked and reconstituted finishes.

\*Not exhaustive list

## NATURAL/EXOTIC VENEERS

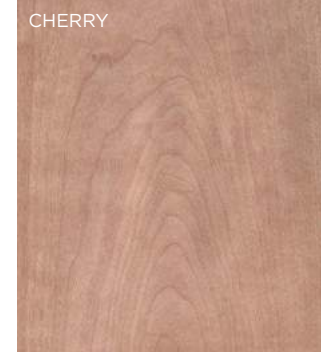

## RECONSTITUTED/SMOKED VENEERS

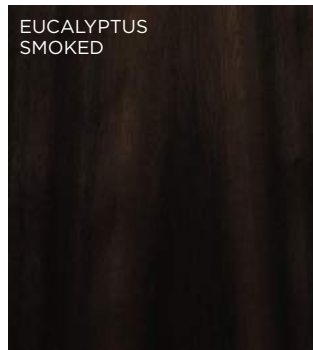
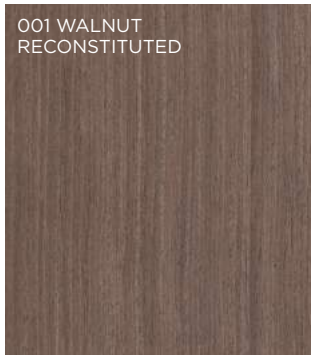

## DYED VENEERS

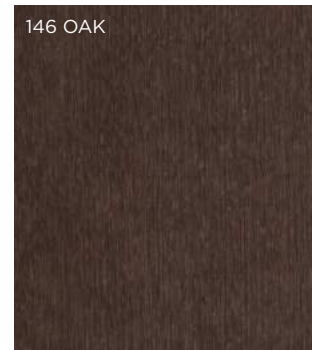
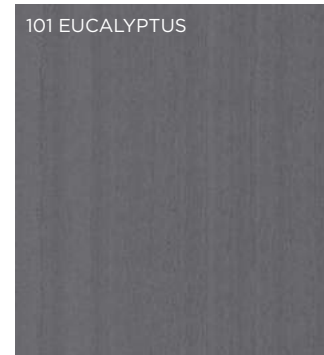
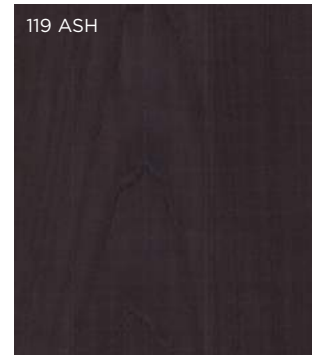
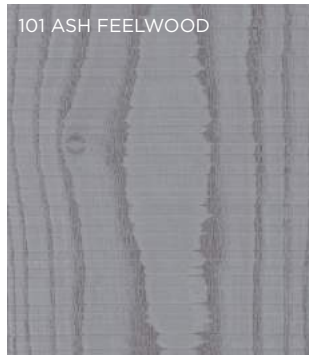

# LAMINATE CHOICES

Choose beautiful laminate finishes to enhance your interiors.

Excellent range of colour or wood alike laminates.

\*Not exhaustive list

## COLOUR LAMINATES

7961 FOG



7921 STORM

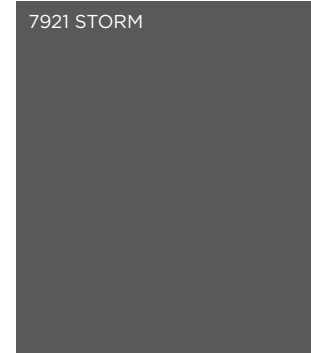

7929 OYSTER GREY

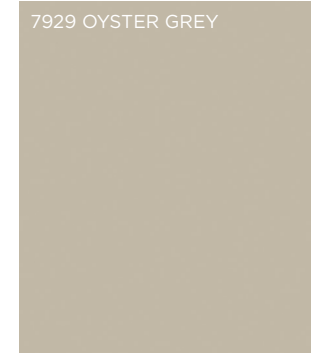

5349 FOSSIL



## WOOD LAMINATES

WHITE ASK



AGED ASH



NAT ELEGANT OAK



NAT LIGHT OAK



LNW MOCCA FIRWOOD

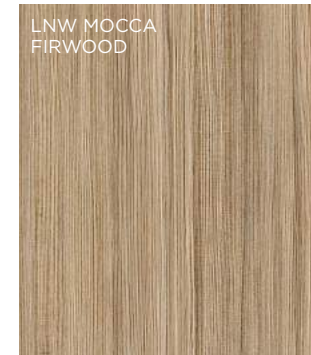

JARRAH LENGU



TOLA OAK

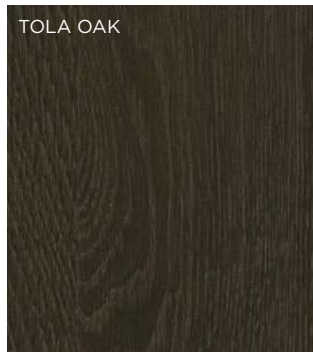

NEVADA OAK



NAR DARK ASH

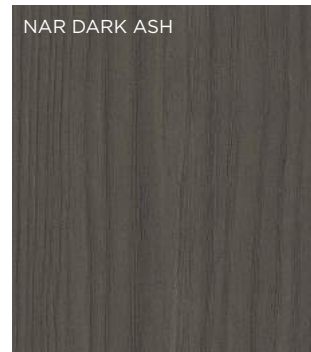

NAT BLACK BIRCH-PLY



BLACKENED LENGU

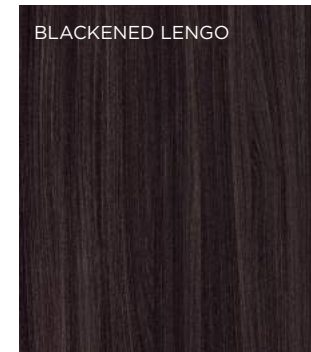

LNW CLASSIC WENGE



# PAINT CHOICES

Choose any RAL colour to closely match your doorset to complement your interior design.

Bespoke colour options available

\*Not exhaustive list

## BLACKS

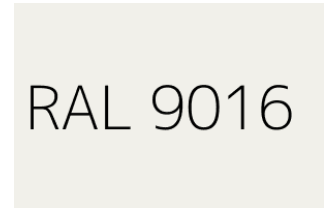
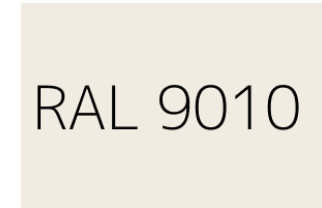
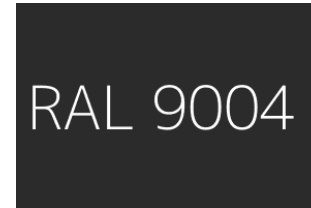
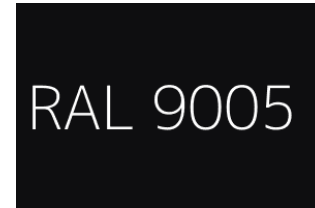

## BROWNS

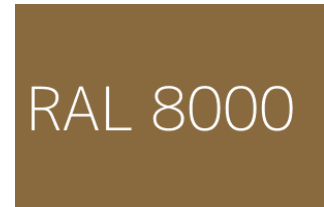
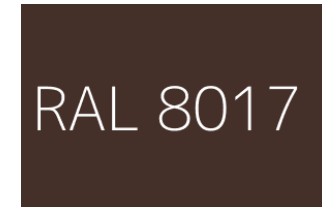
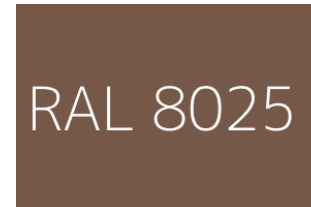
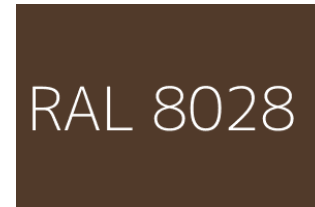

## BLUES

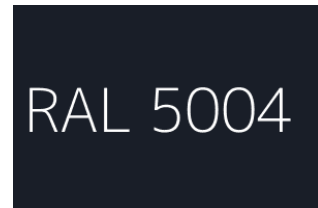

## GREYS

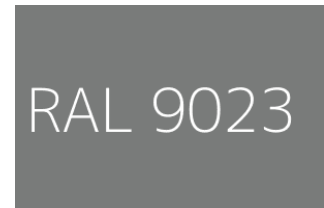
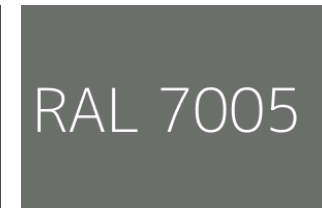
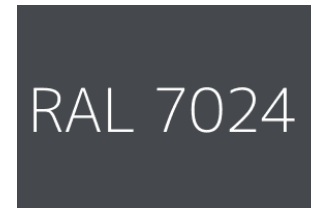
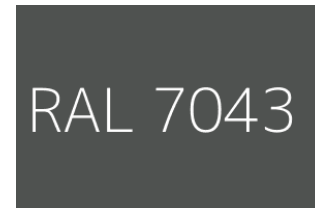

## REDS

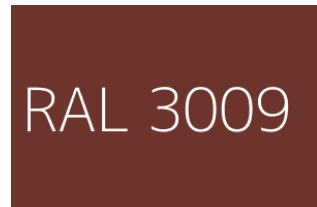
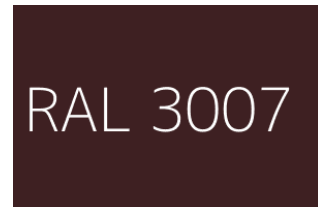

## GREENS

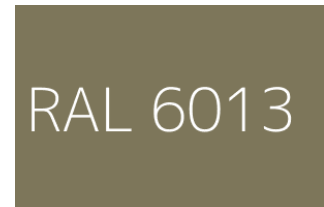
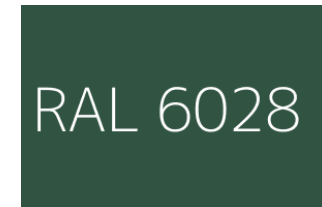
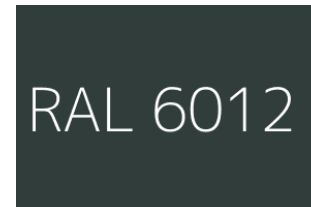
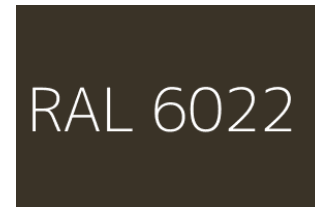



# NOVISTA STEEL RISERS

## FRAME

Concealed/Picture frame design made from 1.2mm steel. 3 or 4 sided frame options

## LEAF

Double skin 1.0mm Zintec Steel with glass wool insulated core. 48mm thick

## CONFIGURATIONS

Single leaf, double leaf and up to six leaves within one frame

## PERFORMANCE

- Fire Rating - FD120(S)
- Acoustic Rating - 41dB Rw (as standard)
- Smoke/Air tested - To BS6375-1, BSEN1634-3 and to BSEN13501-2
- Thermal Resistance - 1.43(m<sup>2</sup>K)/W

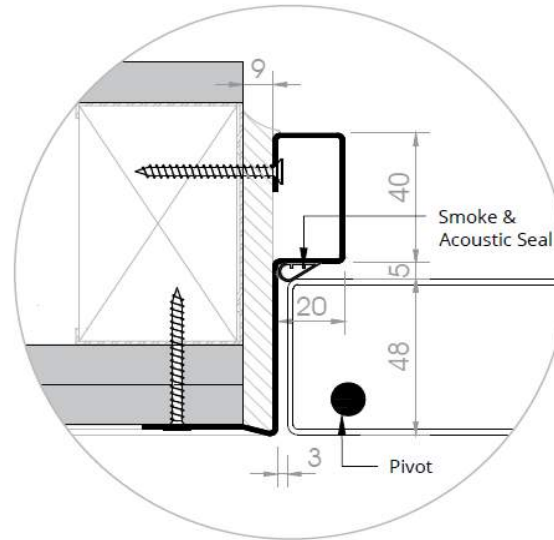

# NOVISTA TIMBER RISERS

## FRAME

Concealed/Picture frame design made from 1.2mm steel. 3 or 4 sided frame options

## LEAF

Solid core to suit application\*

FD30, up to 2500mm high and 800mm wide

leaves\*FD60, up to 2420mm high and 850mm wide\*

## CONFIGURATIONS

Single leaf & double leaf

## PERFORMANCE

- Fire Rating - FD30/60
- Acoustic Rating - up to 35dB Rw
- Smoke/Air tested - To BS6375-1, BSEN1634-3 and to BSEN13501-2
- Thermal Resistance - Consult technical dept.

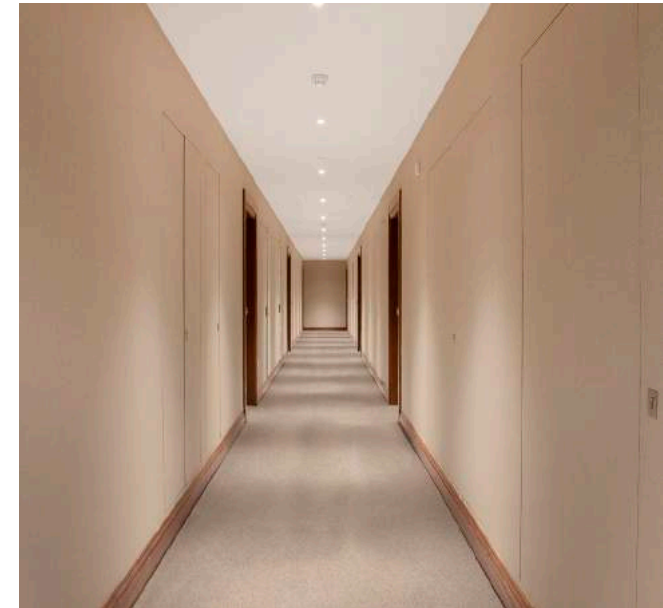
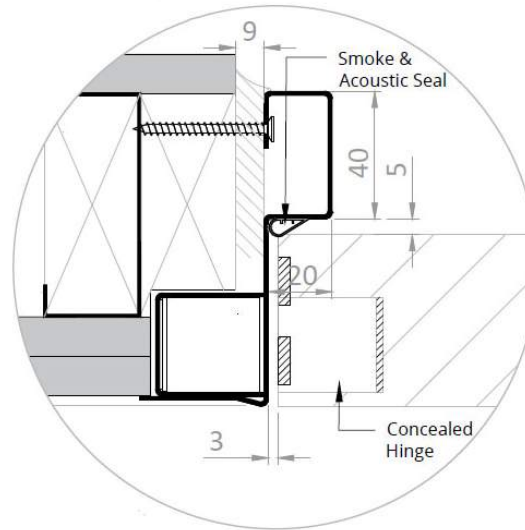

# FLIP LOCK OPTION

NOVISTA RISER STEEL

## CONCEALED LOCK OPTION

Flip lock hides chosen lock mechanism behind a flush hinged pocket.

FD60 fire rated and bi-directionally tested

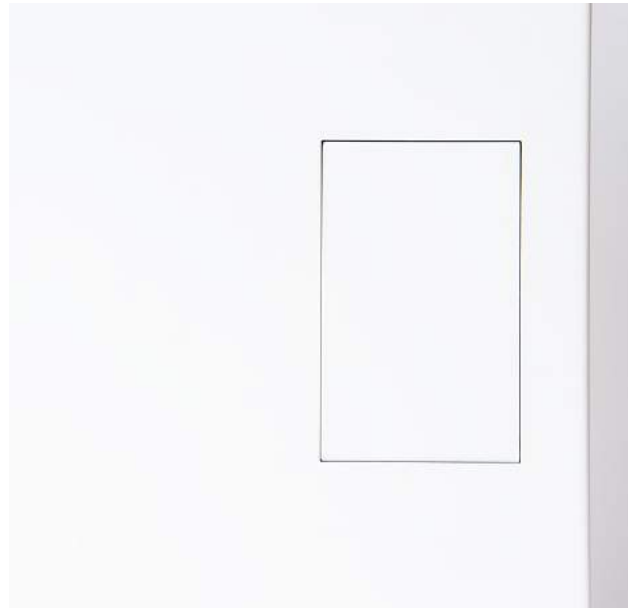

# STEEL DOORS

## INTERNAL DOORS

- FD60, FD120, FD240
- Single or double configurations
- Panel options - solid, glazed, louvered
- Custom-made in a choice of finishes
- Suitable for Masonry, Concrete and Flexible Stud wall
- wall

## EXTERNAL DOORS

- General purpose external door
- Single or double configurations
- Variety of colours and finishes available
- Custom sizes available

## SECURITY DOORS

- Intruder and blast security doors
- **SECUR-DOR2:** low to medium protection, suitable for residential
- **SECUR-DOR3:** medium protection suitable for residential to commercial
- **SECUR-DOR4:** medium to high protection

SINGLE, VISION PANEL



3 PANEL, DOUBLE



6 PANELS, OVERPANEL



1 PANEL, SINGLE



EXTERNAL - LOURVED. DOUBLE



LOURVED, SINGLE





# IRONMONGERY

EXCELLENT RANGE

Ultimate solution of architectural ironmongery from...

- ✓ Lever handles
- ✓ Pull handles
- ✓ Escutcheons
- ✓ Turns and releases
- ✓ Hinges
- ✓ Signage
- ✓ Locks & cylinders
- ✓ Door closers
- ✓ Panic Hardware
- ✓ Miscellaneous

Range of finishes...

- ✓ Satin stainless steel
- ✓ Polished stainless steel
- ✓ Satin Chrome
- ✓ Polished Chrome
- ✓ Black
- ✓ Bronze
- ✓ Satin Brass
- ✓ Polished Brass

## PAS24 Entrance Door Locking Options

- Mechanical key with a 3\* security cylinder
- Salto aElement electronic handle set
- Salto XS4 One Electronic handle set
- NSP Electronic Handle Set

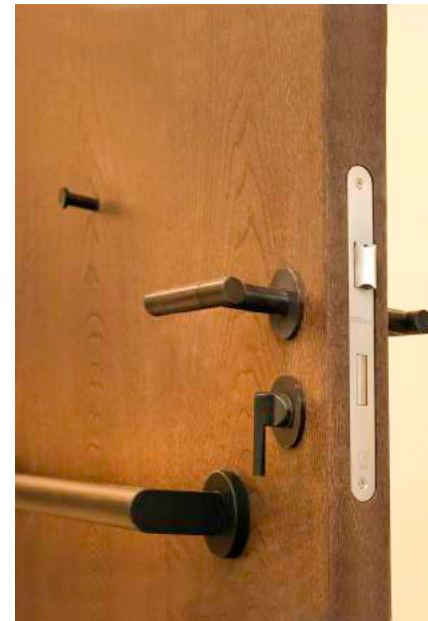

# IRONMONGERY

POPULAR CHOICES

## LEVER HANDLES

Manufactured from stainless steel  
Sprung rose through fixed rose  
Spindle fast fixing system prevents levers  
from pulling off the doors  
Concealed fixings to prevent illegal tampering  
Lever fixed to metal inner rose



## CONCEALED DOOR CLOSER

A high efficiency, true cam action concealed slide  
arm closer. CE marked against EN1154  
Included in successful fire test to EN1634  
Suitable for use on timber fire doors



## DOOR STOP

60031 floor fixed door stop with threaded location  
bolt and rubber buffer. Location bolt extends 15mm  
into the floor providing very secure fixing  
Available in satin/polished stainless steel or  
satin anodised aluminium



## DOOR STOP

Heavy duty floor mounted door stop.  
Concealed fix. Stainless steel material.  
Supplied with fixings

# IRONMONGERY

POPULAR CHOICES

## T BAR PULL HANDLE

Bolt through fixed with M8 machine screws  
Suitable for doors up to 54mm thick  
Available in satin or polished stainless steel  
Dimensions comply with the requirements of  
BS8300 and Approved Document M

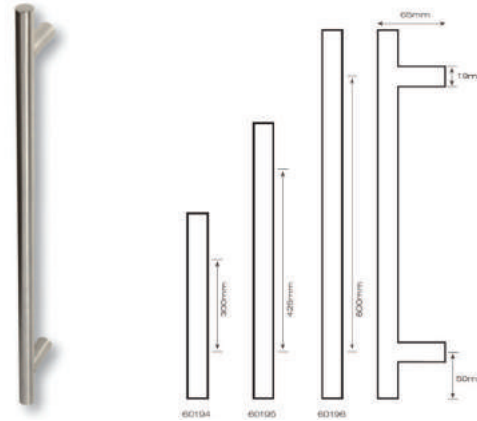

## KICK PLATE

Plates of any size can be manufactured  
Available in satin/polished stainless steel  
or satin anodised aluminium



## FIRE SIGNAGE

Available in satin/polished  
stainless steel or satin anodised aluminium  
Drilled & countersunk for screw fixings  
Screen printed



# Ælement

SALTO SOLUTION

A hotel experience you need to discover. The minimalistic design of the RFID reader looks stylish and discreet on any door. It also offers the choice of a wide range of designer lever handles and finishes

Reader body made using double layered injection construction

Clear dual colour LED light (green/red) to indicate lock authorisation

Special blink and beep indication when lock is in privacy mode

Ability to enable/disable the acoustic signal

Covers door thicknesses: From 35mm to 125mm





## XS4 One

SALTO SOLUTION

The SALTO XS4 One Deadlatch escutcheon is a revolutionary stand-alone electronic lock specially designed to offer a flexible traffic control

- Simple installation is possible on any type of door, including those with narrow frames.
- Body and escutcheon made of steel.
- Available with mechanical cylinder cut outs for key override or access lock outs (override European and Cam profile cylinder) with audit trail facility available.
- Mechanical or electronic privacy option.
- The lock can always be opened from the inside (single action panic feature works in conjunction with the relevant mortise lock).
- Complementary escutcheons without reader available to maintain the aesthetics of doors that do not need to be controlled.
- Covers door thicknesses: From 32mm up to 120mm.





Let's work on specifications together, find us on...



## FREE SAMPLES

Request for door leave samples & ironmongery sample board to see how well we can match your project requirements. Simply email [sales@aspex.co.uk](mailto:sales@aspex.co.uk)

## GET IN TOUCH

[www.aspex.co.uk](http://www.aspex.co.uk) | [info@aspex.co.uk](mailto:info@aspex.co.uk)  
England office: 0116 278 3506  
Scotland office: 01236 720061