

TIMBER DOORSETS

CONCEALED RISERS

ARCHITECTURAL IRONMONGERY

ACCESS CONTROL

aspex

residential
doorsets

www.aspex.co.uk | sales@aspex.co.uk



ABOUT US

Our vision is to offer architectural excellence and this epitomises everything we do..

Aspex offers you the opportunity to add some simplicity to your construction project, as the ultimate source for timber doorsets, risers, architectural ironmongery and access control. Benefit from finding your complete doorset package from one supplier, Aspex, greatly reducing the risk of specification conflict and non-conformance.

Our experienced project consultants can help you make well-informed decisions about your project. Speak to our team about design choices, industry standard or bespoke options, estimating & scheduling, sampling, optimised delivery plans and maintenance tips and more.

Our aim is to support you from design, manufacturing and maintenance, not just supply doorsets.



2006

Aspex was founded on a long-established family historic success and dedication within the architectural ironmongery industry

2010

Introduced access control and integrated systems division. Aspex are Platinum Inspired Business Partners of Salto and work closely with many other manufacturers to secure premises

2012

Introduced supplying timber doorsets working closely with carefully selected door manufacturers

2016

Introduced Novista concealed doorsets, pocket sliding doors and steel and timber risers

2019

Introduced manufacturing of timber doorsets in-house, primarily residential doorsets

2023

Extended factory by 40,000sqft to increase capacity and to bring the production of technical door leaves in-house; manufactured for education, healthcare and commercial sectors

RESIDENTIAL DOORSETS

All of our doorsets available in industry-standard and bespoke sizes and finishes. All available in matching sets for consistent interior design look.

All designs, finishes and styles available for:

- PAS24 Entrance doorsets
- Internal doorsets
- Communal doorsets (with glazed screens & access control)

01 FINISHES

Painted



Veneer



Laminated



02 DESIGNS

Panelled



Grooved



Flush



03 STYLES

Contrasting frame



Matching frame



Wall panelling



PAS24 ENTRANCE DOORSETS

A range of Residential Apartment Entrance doorsets available in industry-standard and bespoke sizes and a variety of different designs and finishes.

The doorsets are supplied fully assembled with the mortice ironmongery installed with frames, extension linings and architraves either primed or finished to match the door leaf.



PAS24 ENTRANCE DOORSETS

DESIGN

- Flush, Paneled or grooved door leaf
- Hardwood rebated frames either primed or finished to match the door leaf
- Adjustable Extension linings
- Architrave in a variety of designs and sizes
- Plinth Blocks
- Wall panels Class 0 rated
- Hardwood thresholds
- Door leaf size of up to 2400mm high and 1200mm wide

FINISH

- Primed - Smooth finish for onsite painting
- Factory Painted - Any RAL colour with the option for different colours on each facing
- Laminated - Extensive colour and wood textures available
- Veneered - Natural wood or dyed options to choose from
- Stained - Select from a standard range or bespoke matching service available

SPECIFICATION

- FD30S (44mm) and FD60S (54mm)
Fire rated
- All fire rated doorsets are manufactured under the stringent IFC certification scheme
- 29db, 32db or 35db Acoustic rated
- PAS24 Tested
- Smoke / Air tested - Compression smoke seals tested in accordance with BS 9999:2017
- FSC Certified
- Key or Electronic locking with either NSP or Salto handle sets
- Concealed or surface mounted door closer



INTERNAL APARTMENT DOORSETS

A range of Residential Apartment doorsets available in industry-standard and bespoke sizes and a range of different designs and finishes.

The doorsets are supplied fully assembled with the mortice ironmongery installed with frames and architraves either primed or finished to match the door leaf.

Stained Veneered



Matte Fog Laminate



Painted Rec Groove



INTERNAL APARTMENT DOORSETS

DESIGN

- Flush, Paneled or grooved door leaf
- Lining and stop or rebated frames either primed or finished to match the door leaf
- Architrave in a variety of designs and sizes
- Plinth Blocks
- Door leaf size of up to 2400mm high and 1200mm wide

FINISH

- Primed – Smooth finish for onsite painting
- Factory Painted – Any RAL colour with the option for different colours on each side
- Laminated – Extensive range available
- Veneered – Natural wood or dyed options to choose from
- Stained – Select from a standard range or bespoke to match other elements in the apartment

SPECIFICATION

- NFR (44mm), FD30S (44mm) and FD60S (54mm) Fire rated
- All fire rated doorsets are manufactured under the stringent IFC certification scheme
- 29db, 32db or 35db Acoustic rated
- FSC Certified



NOVISTA POCKET SLIDING DOORS

Novista sliding door systems are an ideal space saver as the door leaf opens into the wall cavity, leaving the wall and the area around the door clear.

POCKET SLIDING DOORS

- Architrave free
- Sleek and elegant design
- Door completely disappears into wall cavity
- Full height or “infinite” installation possible
- Silent and smooth operation with nylon rollers and aluminum track
- Timber and glass doors
- Single, double or telescopic options

GLASS SLIDING DOORS

- Glass option available on both inwall and full height options
- Glass thickness of 8mm, 10mm or 12mm thick

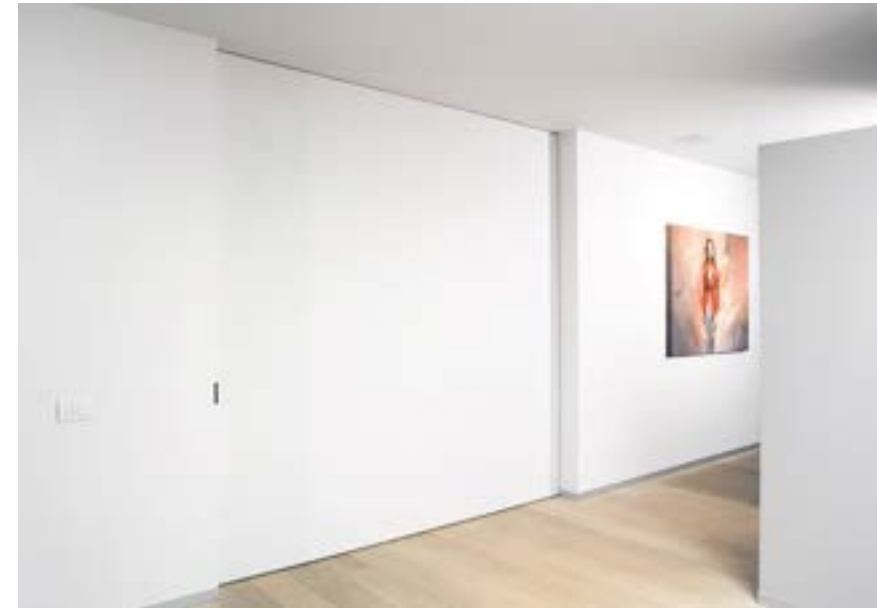

COMMUNAL DOORSETS

A range of doorsets for the communal spaces available in industry-standard and bespoke sizes, and a choice of different designs and finishes.

The doorsets are supplied fully assembled with the mortice ironmongery installed with frames, extension linings and architraves either primed or finished to match the door leaf.

Matte Kashmir Laminate



COMMUNAL DOORSETS

DESIGN

- Flush, Paneled or grooved door leaf
- Lining and stop or rebated frames either primed or finished to match the door leaf
- Adjustable Extension linings
- Architrave in a variety of designs and sizes
- Plinth Blocks
- Wall panels Class 0 rated
- Hardwood thresholds
- Door leaf size of up to 2400mm high and 1200mm wide
- Choice of vision panel designs and sizes available

FINISH

- Primed - Smooth finish for onsite painting
- Factory Painted - Any RAL colour with the option for different colours on each side
- Laminated - Extensive range available
- Veneered - Natural wood or dyed options to choose from
- Stained - Select from a standard range or bespoke to match other elements in the apartment

SPECIFICATION

- NFR (44mm), FD30S (44mm), FD60S (54mm), FD90S (64mm) and FD120 (59mm)
Fire rated
- All fire rated doorsets are manufactured under the stringent IFC certification scheme
- 29db, 32db, 35db or 40db Acoustic rated
- PAS24: 2016 Security rated
- Smoke / Air tested - Compression smoke seals tested in accordance with BS 9999:2017
- FSC Certified



PAS24 ACCESS CONTROLLED COMMUNAL DOORSETS

A range of PAS24 security rated doorsets which can be connected to any access control system

The doorsets are secured using an electric strike and heavy-duty latch and have been PAS24 tested from both sides and these will open automatically in the event of a fire

Available in industry-standard and bespoke sizes and a variety of different designs and finishes.

The doorsets are supplied fully assembled with the electric strike and latch installed with frames, extension linings and architraves either primed or finished to match the door leaf.

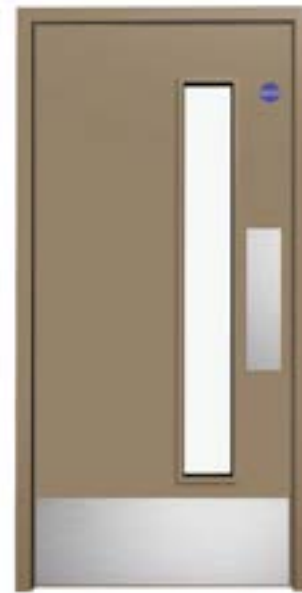

PUSH SIDE



PULL SIDE

Matte Kashmir Laminate

Mocca Firwood Laminate

Classic Wenge Laminate

PAS24 ACCESS CONTROLLED COMMUNAL DOORSETS

DESIGN

- Flush, Paneled or grooved door leaf
- Rebated frames either primed or finished to match the door leaf
- Adjustable Extension linings
- Architrave in a variety of designs and sizes
- Plinth Blocks
- Wall panels Class 0 rated
- Hardwood thresholds
- Door leaf size of up to 2040mm high and 926mm wide
- Vision panel up to 1450 x 200mm

FINISH

- Primed – Smooth finish for onsite painting
- Factory Painted – Any RAL colour with the option for different colours on each side
- Laminated – Extensive range available
- Veneered – Natural wood or dyed options to choose from
- Stained – Select from a standard range or bespoke to match other elements in the apartment

SPECIFICATION

- FD60S (54mm) Fire rated
- All fire rated doorsets are manufactured under the stringent IFC certification scheme
- 29db, 32db or 35db Acoustic rated
- PAS24: 2016 Security rated
- Smoke / Air tested – Compression smoke seals tested in accordance with BS 9999:2017
- FSC Certified
- 12 / 24V Electric strike compatible with any access control system
- Interchangeable between Fail Safe and Fail Locked
- Key Override



PANEL DOORS

DESIGN CHOICE

Luxurious panelled design, great look & feel features enhancing your interiors.

- ✓ 2 Panels
- ✓ 3 Panels
- ✓ 4 Panels

FRAME OPTIONS: Primed frame or matching veneered frame. Extension linings & architraves.

FINISHES

- **Primed** - Smooth finish for onsite painting
- **Factory-painted**- Any RAL colour with the option for different colours on each side
- **Veneered** - Natural wood or dyed options to choose from
- **Stained** - Select from a standard range or bespoke to match other elements in the apartment



GROOVED DOORS

DESIGN CHOICE

Simply stunning grooved design, attention to detail features enhancing your interiors.

- ✓ Ladder
- ✓ Rectangular
- ✓ Bespoke

Groove options:

- ✓ V shape
- ✓ U shape
- ✓ L shape

Inlay options:

- ✓ Contrasting Veneer
- ✓ Aluminium

FINISHES

- **Primed** - Smooth finish for onsite painting
- **Factory-painted** - Any RAL colour with the option for different colours on each side
- **Veneered** - Natural wood or dyed options to choose from
- **Stained** - Select from a standard range or bespoke to match other elements in the apartment

Ladder design



Rectangular design



Veneered + Grooved



FLUSH DOORS

DESIGN CHOICE

Contemporary and elegant

FINISHES

- **Primed** - Smooth finish for onsite painting
- **Factory Painted** - Any RAL colour with the option for different colours on each side
- **Veneered** - Natural wood or dyed options to choose from
- **Stained** - Select from a standard range or bespoke to match other elements in the apartment



VENEER DOORS

FINISH CHOICE

Real wood veneers allow the beauty of the natural wood grain and tone to be brought to life, creating a finish that preserves its true presence.

- ✓ Matt Lacquer
- ✓ Super-matt Lacquer
- ✓ Natural Veneer Crown or Quarter Cut
- ✓ Engineered Veneers
- ✓ Dyed Veneers
- ✓ Stained Veneers



LAMINATED DOORS

FINISH CHOICE

Hard-wearing laminates are ideal for both aesthetic and durability requirements.

- ✓ Laminates are durable and hygienic
- ✓ Ideal choice for high-traffic door applications
- ✓ High-performance surfacing solution

Available in a range of colour and wood texture choices



PAINTED DOORS

FINISH CHOICE

Popular factory-painted doors allow you to touch-up as needed, enhancing the look & feel easily.

Choose any RAL colour to closely match your interior look. Excellent range of standard and bespoke RAL colours

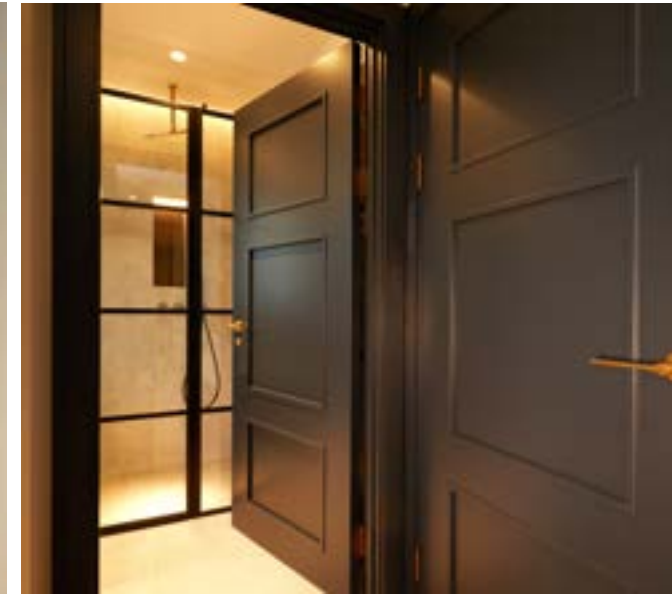

VENEER *choices*

Choose luxurious veneers finishes - from natural, dyed, smoked and reconstituted finishes.

*Not exhaustive list

Request for more choices - sales@aspex.co.uk

NATURAL VENEERS

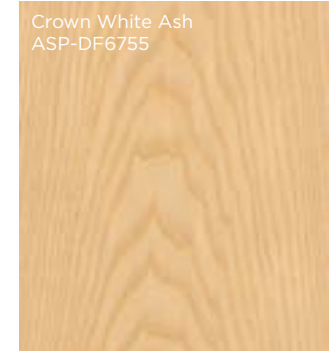
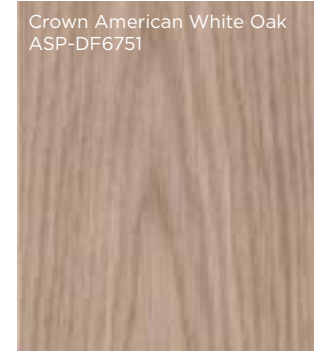
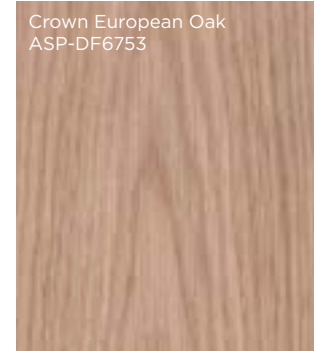
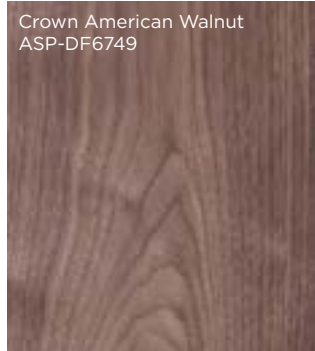

DYED/SMOKED VENEERS

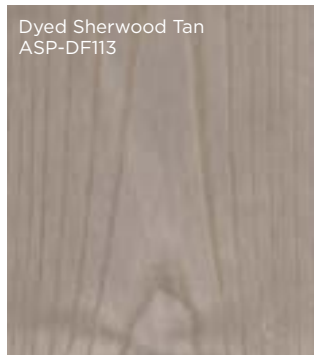

ENGINEERED VENEERS

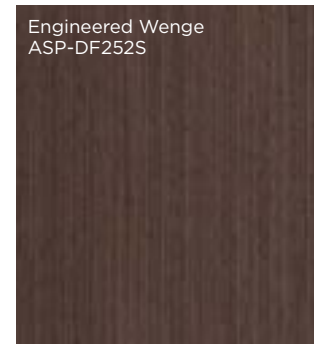
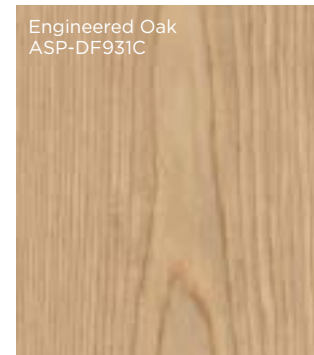

LAMINATE *choices*

Choose beautiful laminate finishes to enhance your interiors. Working with Egger & Formica to offer you high-quality laminates.

*Not exhaustive list

Request for more choices - sales@aspex.co.uk

ESSENTIALS - STANDARD

Light Grey
ASP-EGGU708 ST9



Graphite Grey
ASP-EGGU961 ST7

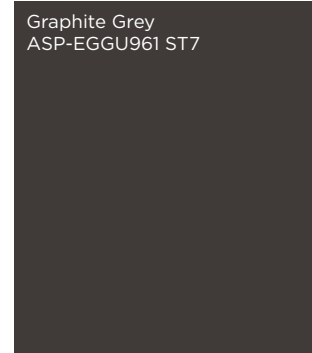

Black
ASP-EGGU999 ST7

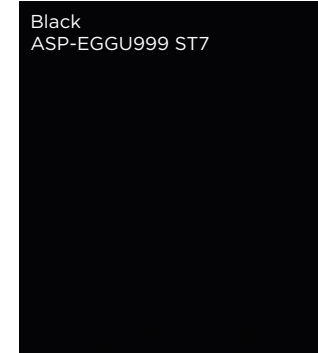

Natural Lancaster Oak
ASP-EGGH3368 ST9

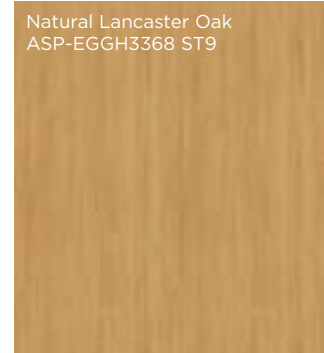

ESSENTIALS - EXTENDED

Brown Warmia Walnut
ASP-EGGH1307 ST19

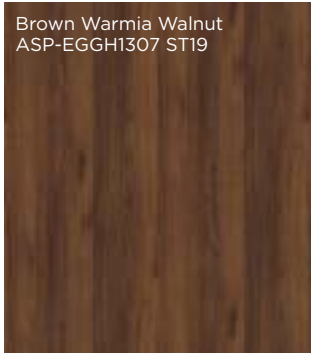

Brown Tonsberg Oak
ASP-EGGH309 ST12

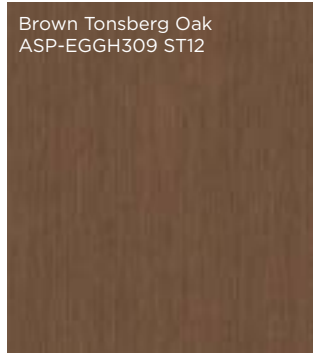

DOOR COLLECTION

Vicenza Oak
ASP-EGGH3157 ST12

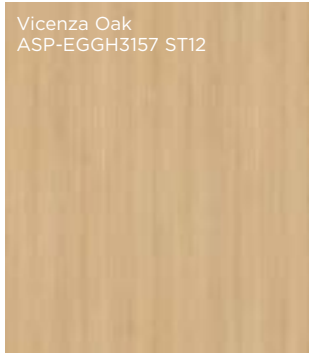

Beige Grey Lorenzo Oak
ASP-EGGH3146 ST19

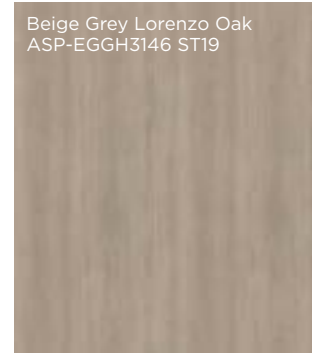

Natural Davos Oak
ASP-EGGH3131 ST12

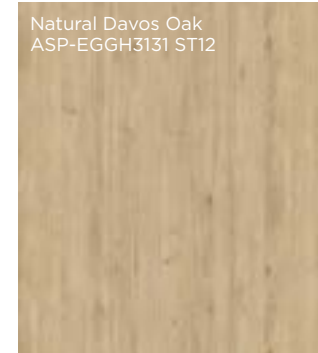

Dark Brown Eucalyptus
ASP-EGGH3043 ST12

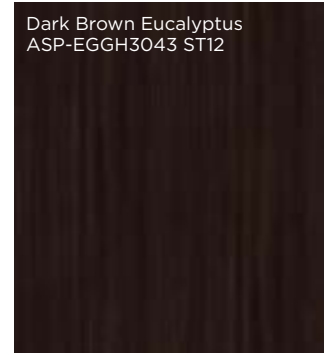

Truffle Brown Denver Oak
ASP-EGGH1399 ST10

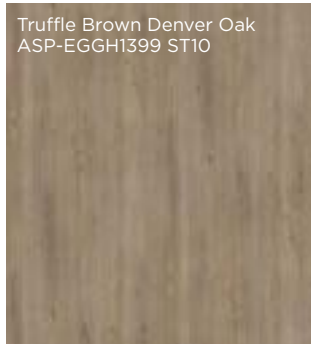

Natural Hamilton Oak
ASP-EGGH3303 ST10

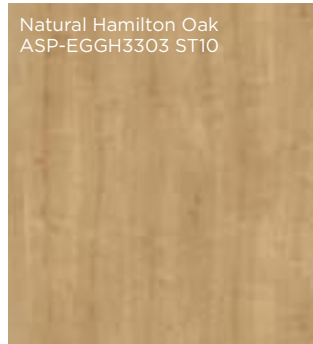

Sevilla Ash
ASP-EGGH1223 ST19

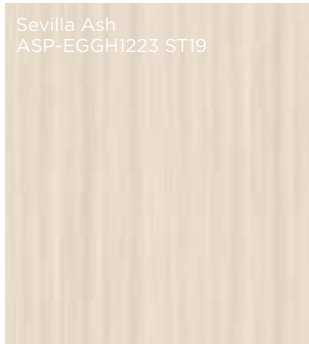

Natural Sheffield Acacia
ASP-EGGH1242 ST10

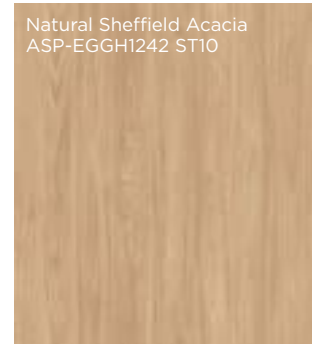

Brown Belmont Oak
ASP-EGGH1303 ST12

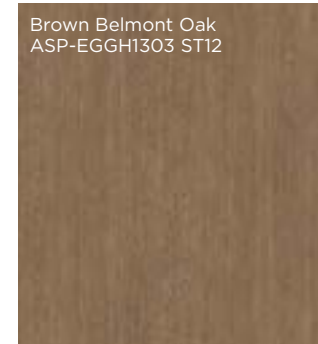

Lincoln Walnut
ASP-EGGH1714 ST19



RAL choices

Choose any RAL colour to closely match your doorset to complement your interior design. Bespoke colour options available

*Not exhaustive list

Request for more choices - sales@aspex.co.uk

BLUES

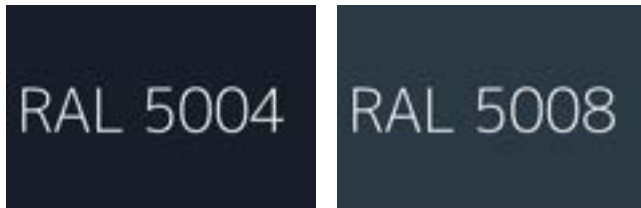

REDS

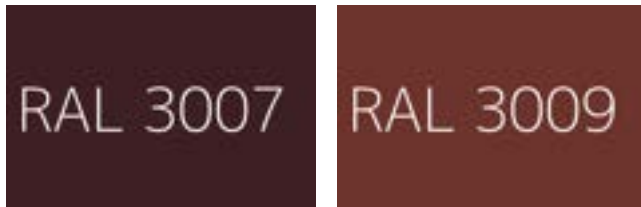

BLACKS

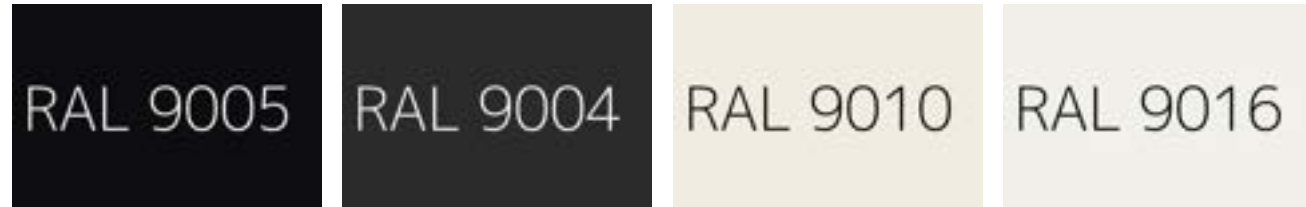

BROWNS

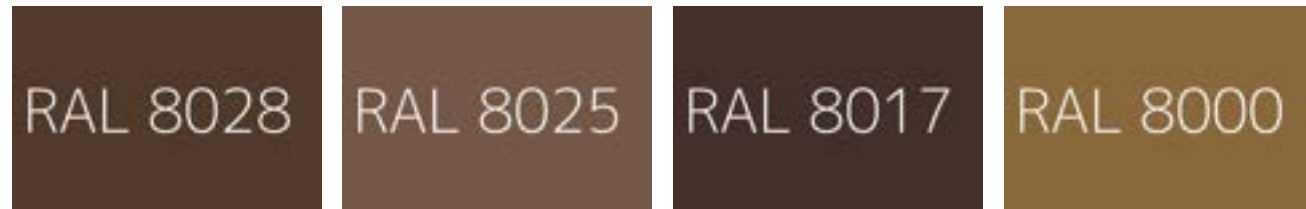

GREYS

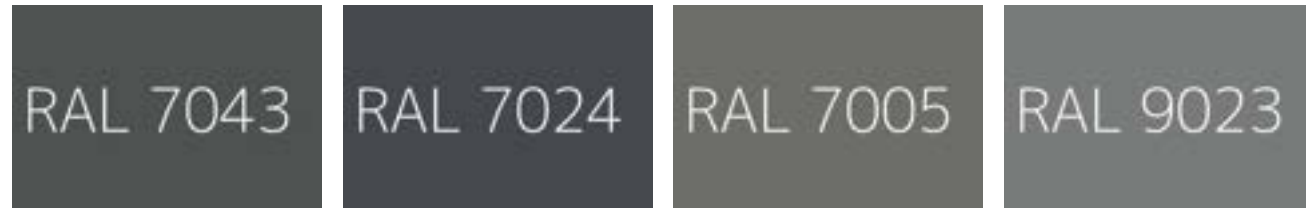

GREENS

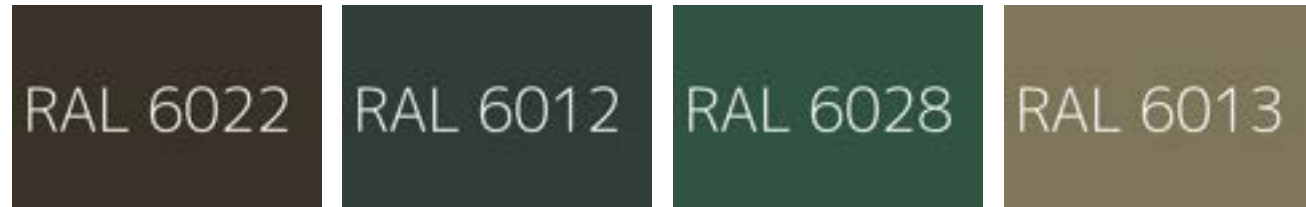

NOVISTA STEEL RISERS

FRAME

Concealed/Picture frame design made from 1.2mm steel. 3 or 4 sided frame options

LEAF

Double skin 1.0mm Zintec Steel with glass wool insulated core. 48mm thick

CONFIGURATIONS

Single leaf, double leaf and up to six leaves within one frame

PERFORMANCE

- Fire Rating - FD120(S)
- Acoustic Rating - 41dB Rw (as standard)
- Smoke/Air tested - To BS6375-1, BSEN1634-3 and to BSEN13501-2
- Thermal Resistance - 1.43(m²K)/W

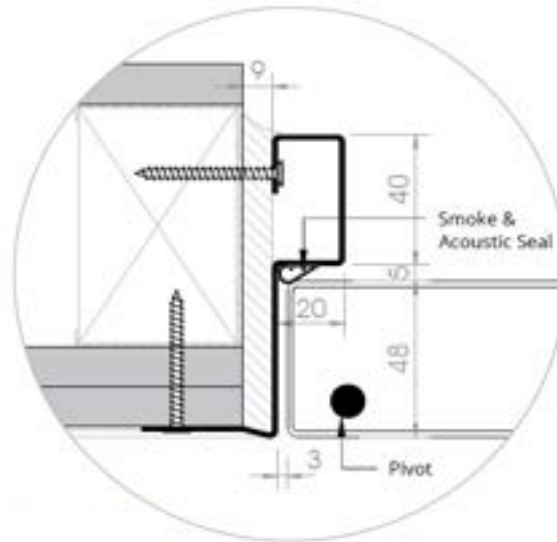

INTU-FRAME OPTION

NOVISTA RISER STEEL

DRY-INTUMESCENT FRAME

Factory-fitted to riser frames, the dry intumescent seal expands behind the frame to seal tolerance gaps up to 15mm in event of fire, taking the place of fire foam. Fire rated to FD120

BI-DIRECTIONAL FIRE-TESTING

In line with current construction trends, Novista Risers are tested from both directions of attack from fire when fitted with intu-frame protection option



FLIP LOCK OPTION

NOVISTA RISER STEEL

CONCEALED LOCK

Flip lock hides chosen lock mechanism behind a flush hinged pocket.

FD60 fire rated and bi-directionally tested

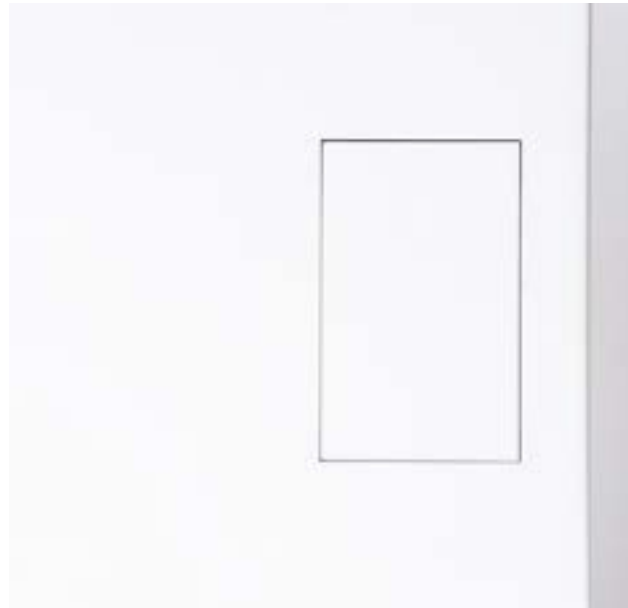

NOVISTA TIMBER RISERS

FRAME

Concealed/Picture frame design made from 1.2mm steel. 3 or 4 sided frame options

LEAF

Solid core to suit application*

FD30, up to 2500mm high and 800mm wide

leaves*FD60, up to 2420mm high and 850mm wide*

CONFIGURATIONS

Single leaf & double leaf

PERFORMANCE

- Fire Rating - FD30/60
- Acoustic Rating - up to 35dB Rw
- Smoke/Air tested - To BS6375-1, BSEN1634-3 and to BSEN13501-2
- Thermal Resistance - Consult technical dept.

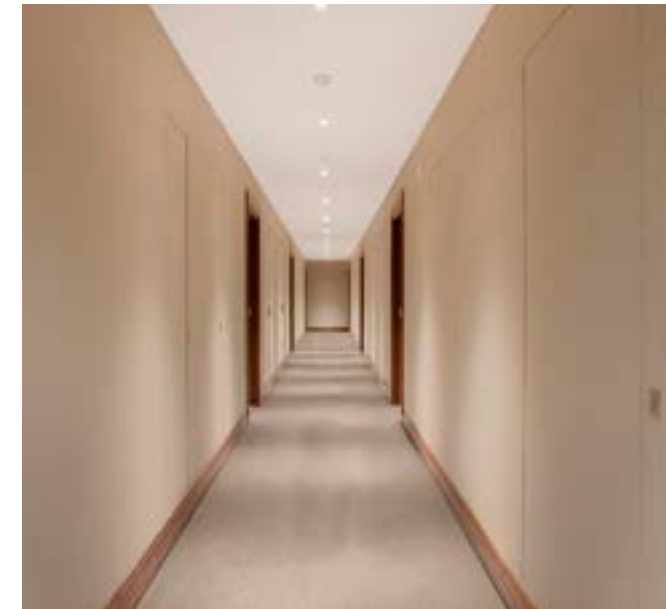
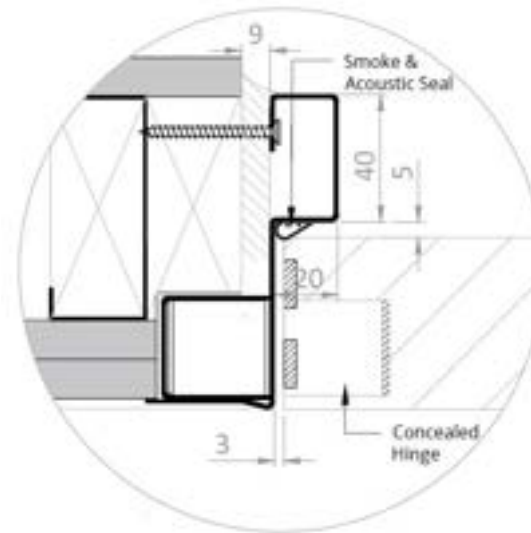

STEEL DOORS

INTERNAL DOORS

- FD60, FD120, FD240
- Single or double configurations
- Panel options - solid, glazed, louvered
- Custom-made in a choice of finishes
- Suitable for Masonry, Concrete and Flexible Stud wall

EXTERNAL DOORS

- General purpose external door
- Single or double configurations
- Variety of colours and finishes available
- Custom sizes available

SECURITY DOORS

- Intruder and blast security doors
- **SECUR-DOR2:** low to medium protection, suitable for residential
- **SECUR-DOR3:** medium protection suitable for residential to commercial
- **SECUR-DOR4:** medium to high protection

SINGLE, VISION PANEL



3 PANEL, DOUBLE



6 PANELS, OVERPANEL



1 PANEL, SINGLE



EXTERNAL - LOUVERED, DOUBLE



LOUVERED, SINGLE



IRONMONGERY

EXCELLENT RANGE

Ultimate solution of architectural ironmongery from...

- ✓ Lever handles
- ✓ Pull handles
- ✓ Escutcheons
- ✓ Turns and releases
- ✓ Hinges
- ✓ Signage
- ✓ Locks & cylinders
- ✓ Door closers
- ✓ Panic Hardware
- ✓ Miscellaneous

Range of finishes...

- ✓ Satin stainless steel
- ✓ Polished stainless steel
- ✓ Satin Chrome
- ✓ Polished Chrome
- ✓ Black
- ✓ Bronze
- ✓ Satin Brass
- ✓ Polished Brass

PAS24 Entrance Door Locking Options

- Mechanical key with a 3* security cylinder
- Salto aElement electronic handle set
- Salto XS4 One Electronic handle set
- NSP Electronic Handle Set

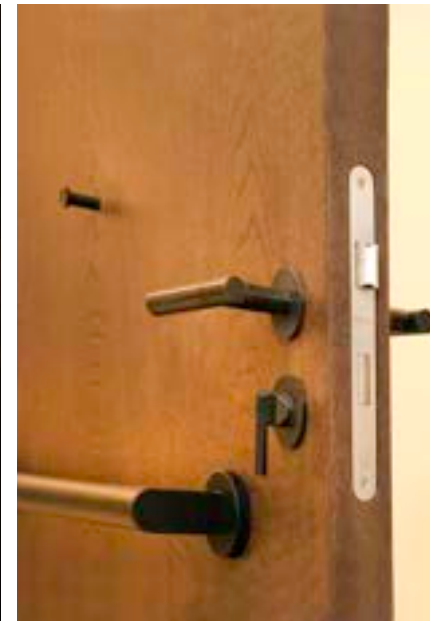

IRONMONGERY

POPULAR CHOICES

LEVER HANDLES

Manufactured from stainless steel
Sprung rose through fixed rose
Spindle fast fixing system prevents levers
from pulling off the doors
Concealed fixings to prevent illegal tampering
Lever fixed to metal inner rose



CONCEALED DOOR CLOSER

A high efficiency, true cam action concealed slide
arm closer. CE marked against EN1154
Included in successful fire test to EN1634
Suitable for use on timber fire doors



DOOR STOP

60031 floor fixed door stop with threaded location
bolt and rubber buffer. Location bolt extends 15mm
into the floor providing very secure fixing
Available in satin/polished stainless steel or
satin anodised aluminium



DOOR STOP

Heavy duty floor mounted door stop.
Concealed fix. Stainless steel material.
Supplied with fixings

IRONMONGERY

POPULAR CHOICES

T BAR PULL HANDLE

Bolt through fixed with M8 machine screws
Suitable for doors up to 54mm thick
Available in satin or polished stainless steel
Dimensions comply with the requirements of
BS8300 and Approved Document M

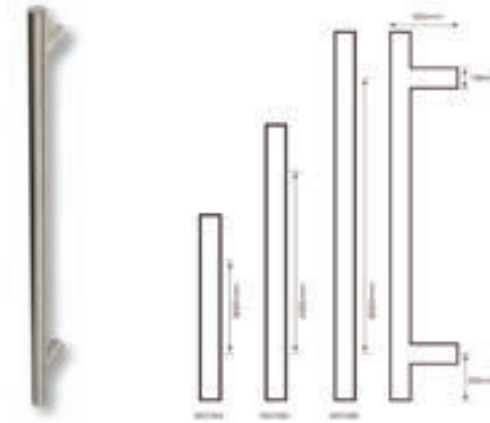

KICK PLATE

Plates of any size can be manufactured
Available in satin/polished stainless steel
or satin anodised aluminium



FIRE SIGNAGE

Available in satin/polished
stainless steel or satin anodised aluminium
Drilled & countersunk for screw fixings
Screen printed



Ælement

SALTO SOLUTION

A hotel experience you need to discover. The minimalistic design of the RFID reader looks stylish and discreet on any door. It also offers the choice of a wide range of designer lever handles and finishes

Reader body made using double layered injection construction

Clear dual colour LED light (green/red) to indicate lock authorisation

Special blink and beep indication when lock is in privacy mode

Ability to enable/disable the acoustic signal

Covers door thicknesses: From 35mm to 125mm



XS4 One

SALTO SOLUTION

The SALTO XS4 One Deadlatch escutcheon is a revolutionary stand-alone electronic lock specially designed to offer a flexible traffic control

- Simple installation is possible on any type of door, including those with narrow frames.
- Body and escutcheon made of steel.
- Available with mechanical cylinder cut outs for key override or access lock outs (override European and Cam profile cylinder) with audit trail facility available.
- Mechanical or electronic privacy option.
- The lock can always be opened from the inside (single action panic feature works in conjunction with the relevant mortise lock).
- Complementary escutcheons without reader available to maintain the aesthetics of doors that do not need to be controlled.
- Covers door thicknesses: From 32mm up to 120mm.





OUR PROJECTS

SOME OF OUR PROJECTS
completed residential projects



Potato Wharf, Manchester



Manchester New Square, Manchester



Holloway Head, Birmingham



Wellington Place, Leeds



Lancer Square, London



Chelsea Creek, London

POTATO WHARF

MANCHESTER

Residential scheme designed for sustainable living based in Manchester. 191 new apartments with private terraces & canal-side views.

Aspex supplied Integra PAS24 entrance doorsets, NFR living & communal doorsets, Novista steel risers and ironmongery.



SUGAR HOUSE ISLAND

LONDON

A 26-acre neighbourhood comprising 1,200 mews homes and riverside apartments.

Aspex supplied entrance doorsets (different colour on either side), communal doorsets and Novista steel risers.



LANDMARK PINNACLE

LONDON

Landmark Pinnacle is a 233-metre skyscraper comprising of 75 floors - it is the tallest residential tower in the UK

Aspex have supplied timber doorsets, ironmongery and Novista steel risers. PAS24 apartment entrance doorsets supplied in stained veneer styled with architraves or wall panels, plus flush and glazed communal doorsets.



RUSKIN SQUARE

LONDON

Ruskin Square was the first project where we supplied Novista Riser doors in 2016. Mixed use space - retail & offices.

Aspex supplied Novista Risers Doors.





Let's work on specifications together, find us on...



FREE SAMPLES

Request for door leave samples & ironmongery sample board to see how well we can match your project requirements. Simply email sales@aspex.co.uk

GET IN TOUCH

www.aspex.co.uk | sales@aspex.co.uk
England office: 0116 278 3506
Scotland office: 01236 720061