

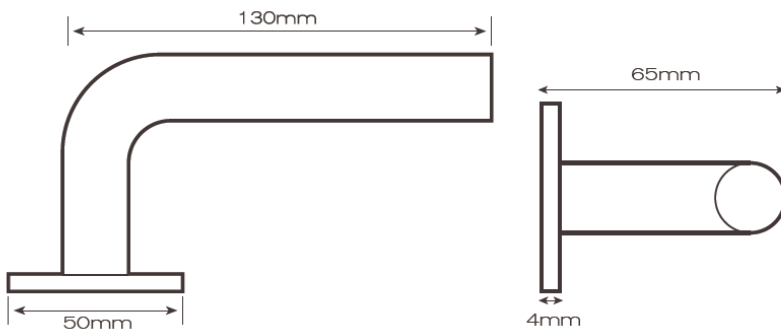

## Lever Handle



### 13163 16mm lever handle on 50x4mm rose

- Manufactured from grade 316 stainless steel
- Maintenance free ball bearing system
- Through fixed roses
- Spindle fast fixing system prevents levers from pulling off the doors
- Concealed fixings to prevent illegal tampering
- Lever fixed to metal inner rose
- CE marked

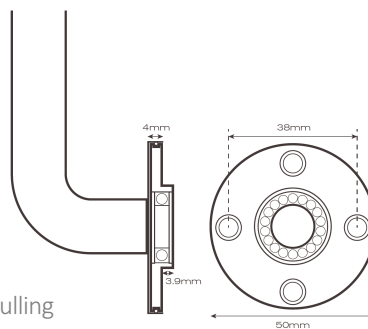

## Maintenance

To be carried out by approved specialist only. No abrasives or chemicals to be used. Wipe with soft damp cloth or, when necessary, warm soapy water and a soft cloth. Every three months, check that the lever handle grub screw is flush with the surface on the handle. If it is projecting, retighten it. If the rose is loose, remove the rose cover and tighten the through fixing bolts.

If for any reason the products fail due to a defect in manufacture, contact us and we will advise you of the replacement procedure.